

TIRADORES | HANDLES | POIGNÉES



CUBIC



a	b	c	d		Cod.
224	250	22	25	Cromo mate Matt chrome Chrome mat	800098
160	200	22	25	Cromo mate Matt chrome Chrome mat	800100

GLASS



a	b	c	d		Cod.
160	174	25	20	Cromo look Look chrome Chrome look	800036

FINE



a	b	c	d		Cod.
160	175	35	10	Cromo mate Matt chrome Chrome mat	800116
192	205	35	10	Cromo mate Matt chrome Chrome mat	800117

2600



a	b	c	d		Cod.
128	152	30	20	Cromo mate Matt chrome Chrome mat	800001

LOW



a	b	c, c'	d		Cod.
192	206	52-47	13.5	Cromo brillo Shining chrome Chrome brillant	802013
192	206	52-47	13.5	Níquel cepillado Brushed níquel Níquel brossé	802014

HIDE



a	b	c	d		Cod.
128	200	16,5	17,4	Cromo look Look chrome Chrome look	802010

2395 VITRINA ALUMINIO P4

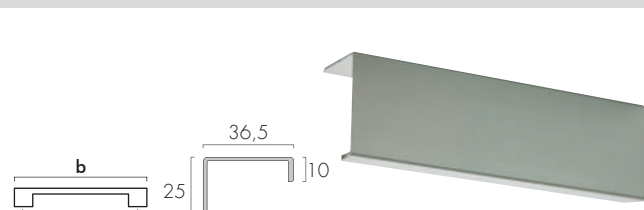

a	b		Cod.
192	216	Aluminio Aluminum Aluminium	809001

2478 VITRINA ALUMINIO P4 INTEGRADO

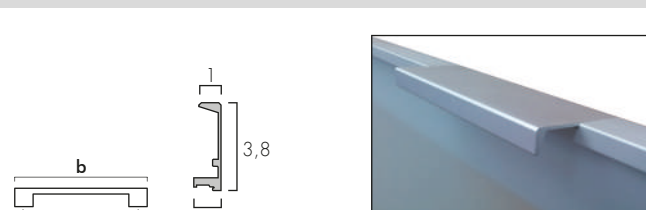

a	b		Cod.
126	-	Aluminio Aluminum Aluminium	809002

400



a	b	c	d		Cod.
160	180	35	15	Aluminio Aluminum Aluminium	800085
192	212	35	15	Aluminio Aluminium Aluminium	800086

1005



a	b	c	d		Cod.
192	242	32	10	Aluminio Aluminum Aluminium	800043

ARCH



a	b	c	d		Cod.
192	209	36	15	Cromo brillo Shining chrome Chrome brillant	800174
192	209	36	15	Níquel cepillado Brushed nickel Níquel brossé	800175

SENSE



a	b	c	d		Cod.
192	199	30	25	Cromo brillo Shining chrome Chrome brillant	800180
192	199	30	25	Inox look Inox look Inox look	800181
192	199	30	25	Negro cepillado Brushed black Noir brossé	800182

U056



a	b	c	d		Cod.
192	200	8,5	28,5	Níquel cepillado Brushed nickel Níquel brossé	800202
192	200	8,5	28,5	Latón cepillado Brushed brass Laiton brossé	800206
192	200	8,5	28,5	Negro mate Black matt Noir mat	800205
192	200	8,5	28,5	Blanco mate White matt Blanc mat	800204
192	200	8,5	28,5	Titanio Titanium Titane	800208

FLOID



a	b	c	d		Cod.
192	207,6	31	15,6	Oro cepillado Brushed gold Or brossé	800275
192	207,6	31	15,6	Plata Peltre Silver Peltre Argent Peltre	800276
192	207,6	31	15,6	Negro mate Black matt Noir mat	800277

ARROW



a	b	c	d		Cod.
192	223	36	20	Cromo brillo Shining chrome Chrome brillant	800176
192	223	36	20	Níquel cepillado Brushed nickel Níquel brossé	800177

BICOLOR 850



a	b	c	d		Cod.
160	178	12	25	Blanco, negro, níquel satinado, cobre White, black, satin Nickel, copper Blanc, noir, nickel satiné, cuivre	800241

Nota: ver combinaciones de color / Note: see color combinations / Remarque: voir combinaisons de couleurs

GRAFF 430

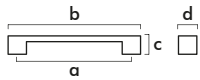

a	b	c	d		Cod.
160	182	33	10		800281
1178	1200	33	10	Negro cepillado Brushed black Brossé noir	800282
160	182	33	10		800285
1178	1200	33	10	Latón cepillado Brushed brass Laiton brossé	800286

POMO T GRAFF 430



a	b	c	d		Cod.
60	33	-	-		801038
60	33	-	-	Negro cepillado Brushed black Brossé noir	801039
60	33	-	-		801039
60	33	-	-	Latón cepillado Brushed brass Laiton brossé	801039

BARRA ACERO INOX

a	b	c	d		Cod.
128	192	32	12		803001
160	224	32	12		192
192	256	32	12		224
242	306	32	12		256
292	356	32	12		306
342	406	32	12		356
392	456	32	12		406
492	556	32	12		456
592	656	32	12		556
692	756	32	12		656
792	856	32	12		756
1092	1156	32	12		856
1192	1256	32	12		1156
					1256

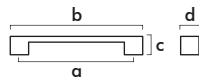
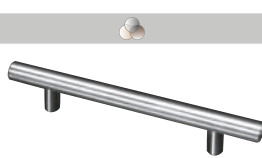

BRAVE 452

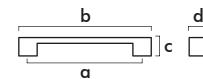

a	b	c	d		Cod.
192	240	26	8		800253
192/992	1040	33	8	Blanco White Blanc	800263
192	240	26	8		800254
192/992	1040	33	8	Negro Black Noir	800264
192	240	26	8		800259
192/992	1040	33	8	Metal Marrón Brown Metal Métal brun	800269

VANN 375

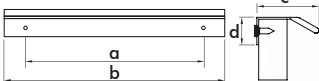

a	b	c	d		Cod.
128	200	44	19,7		800552
128	200	44	19,7	Inox look Inox look	
128	200	44	19,7		800526
128	200	44	19,7	Latón cepillado Brushed brass Laiton brossé	
128	200	44	19,7		800525
128	200	44	19,7	Negro mate Black matt Noir mat	

CUTT 322

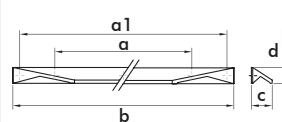

a	a1	b	c	d		Cod.
96	128	200	23	17,5		800512
96	128	200	23	17,5	Inox look Inox look	
96	128	200	23	17,5		800515
96	128	200	23	17,5	Negro mate Black matt Noir mat	

WALLACE 0503

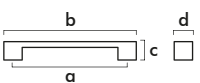

a	b	c	d		Cod.
128	210	15,8	30,7		802541
128	210	15,8	30,7	Cromo brillo Shining chrome Chrome brillant	
128	210	15,8	30,7		802545
128	210	15,8	30,7	Níquel negro brillo Shiny black nickel Nickel noir b.	
128	210	15,8	30,7		802546
128	210	15,8	30,7	Latón brillo Glossy brass Laiton brillant	

REDO 226

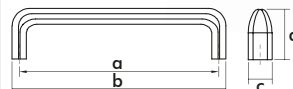

a	b	c	d		Cod.
192	201	15	32		800216
192	201	15	32	Cobre cepillado Brushed copper Bronze brossé	
192	201	15	32		800215
192	201	15	32	Negro peltre Black pewter Noir étain	

CLASSIC 348

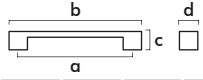

a	b	c	d		Cod.
160	170	26	24		Bronce viejo Aged bronze Bronze vieille 800235
160	170	26	24		Plata vieja Old silver Vieil argent 800236
160	170	26	24		Cobre rústico Rustic copper Cuiivre rustique 800237

CLASSIC 349

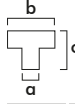

a	b	c	d		Cod.
16	35	28	-		Bronce viejo Aged bronze Bronze vieille 801035
16	35	28	-		Plata vieja Old silver Vieil argent 801036
16	35	28	-		Cobre rústico Rustic copper Cuiivre rustique 801037

7372

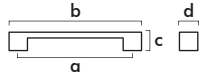

a	b	c	d		Cod.
96	137	28	20		Níquel negro cepillado Brushed black nickel Níquel brossé noir 800061

8841

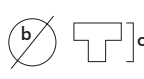
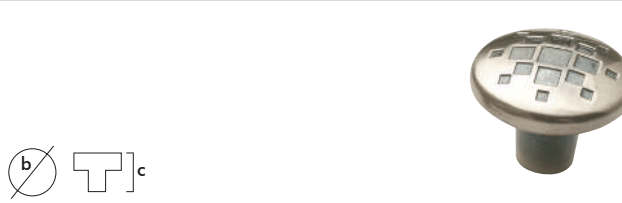

a	b	c	d		Cod.
-	35	25	-		Níquel negro cepillado Brushed black nickel Níquel brossé noir 801016

9822

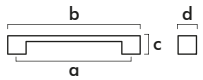

a	b	c	d		Cod.
96	137	28	20		Rústico bronce porcelana craquele Rusty bronze cracked porcelain Bronze rustique porcelaine craquelé 800062

9831



a	b	c	d		Cod.
-	35	25	-		Rústico bronce porcelana craquele Rusty bronze cracked porcelain Bronze rustique porcelaine craquelé 801015

AVA 394

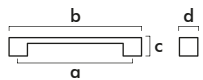

a	b	c	d		Cod.
96	128,5	29	26		Peltre Peltre Peltre 800271
96	128,5	29	26		Latón antiguo Antique brass Cuiivre rustique 800270

PETRA

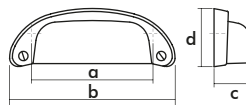
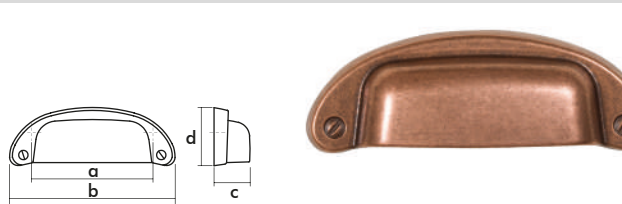

a	b	c	d		Cod.
64	97	19	34,5		Plata antigua Antique silver Argent ancien 802020
64	97	19	34,5		Cobre antiguo Antique copper Bronze ancien 802021
64	97	19	34,5		Negro mate Black matt Noir mat 802022

S140 LINEAR

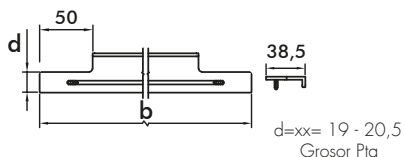

	b	c	d		Cod.
	148	10	19 - 20,5		803140
15	148	10	19 - 20,5		15 - xx
20	198	10	19 - 20,5		20 - xx
25	248	10	19 - 20,5		25 - xx
30	298	10	19 - 20,5		30 - xx
35	348	10	19 - 20,5		35 - xx
40	398	10	19 - 20,5		40 - xx
45	448	10	19 - 20,5		45 - xx
50	498	10	19 - 20,5		50 - xx
60	598	10	19 - 20,5		60 - xx
70	698	10	19 - 20,5		70 - xx
80	798	10	19 - 20,5		80 - xx
90	898	10	19 - 20,5		90 - xx
100	998	10	19 - 20,5		100 - xx
120	1198	10	19 - 20,5		120 - xx

Inox | Inox | Inox

S250 FORMA

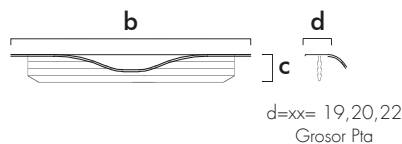

	b	c	d		Cod.
	147	10	19 - 20 - 22		803250
15	147	10	19 - 20 - 22		15 - xx
20	197	10	19 - 20 - 22		20 - xx
25	247	10	19 - 20 - 22		25 - xx
30	297	10	19 - 20 - 22		30 - xx
35	347	10	19 - 20 - 22		35 - xx
40	397	10	19 - 20 - 22		40 - xx
45	447	10	19 - 20 - 22		45 - xx
50	497	10	19 - 20 - 22		50 - xx
60	597	10	19 - 20 - 22		60 - xx
70	697	10	19 - 20 - 22		70 - xx
80	797	10	19 - 20 - 22		80 - xx
90	897	10	19 - 20 - 22		90 - xx
100	997	10	19 - 20 - 22		100 - xx
120	1197	10	19 - 20 - 22		120 - xx

Inox | Inox | Inox

S340 GRADA

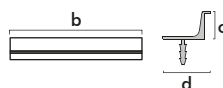

	b	c	d		Cod.
15	147	11	16		
20	197	11	16		803340
25	247	11	16		803342
30	297	11	16		803343
35	347	11	16		803344
40	397	11	16		
45	447	11	16		
50	497	11	16		
60	597	11	16		
70	697	11	16		
80	797	11	16		
90	897	11	16		
100	997	11	16		
120	1197	11	16		

Aluminio
Aluminum | Aluminium

Inox look
Inox look | Inox look

Blanco
White | Blanc

Negro
Black | Noir

S400

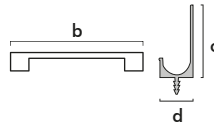
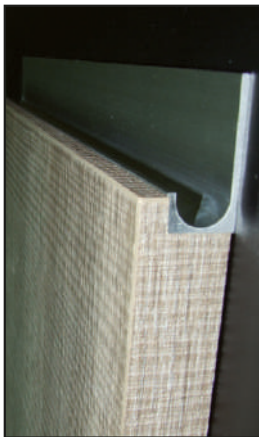

h	b	c	d
30	298	35	16
35	348	35	16
40	398	35	16
45	448	35	16
50	498	35	16
60	598	35	16
70	698	35	16
80	798	35	16
90	898	35	16
100	998	35	16
120	1118	35	16
130	1218	35	16
250	2418	35	16

Cod.	Color	Finish
803410	Aluminio mate Matt Aluminum Aluminium Mat	
803411	Cromo brillo Shining chrome Chrome brillant	
803412	Inox Inox Inox	
803413	Blanco mate Matt white Blanc mat	
803414	Negro mate Matt Black Noir mat	

S401

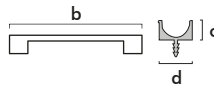

h	b	c	d
30	298	9,2	16
35	348	9,2	16
40	398	9,2	16
45	448	9,2	16
50	498	9,2	16
60	598	9,2	16
70	698	9,2	16
80	798	9,2	16
90	898	9,2	16
100	998	9,2	16
120	1118	9,2	16
130	1218	9,2	16
250	2418	9,2	16

Cod.	Color	Finish
803420	Aluminio mate Matt aluminum Aluminium mat	
803421	Cromo brillo Shining chrome Chrome brillant	
803422	Inox Inox Inox	
803423	Blanco mate Matt white Blanc mat	
803424	Negro mate Matt black Noir mat	

SERIE GOLA

GOLA - PERFIL J

GOLA - PROFILE J | GOLA - PROFIL J



a†	b	c			Cod.
57	4 Mts	26	Aluminio Aluminum Aluminium		400 A
57	4 Mts	26	Blanco White Blanc		400 B
57	4 Mts	26	Negro Black Noir		400 N
57	4 Mts	26	Oro Grata Grata Gold Or Grata		400 O

GOLA - PERFIL U

GOLA - PROFILE U | GOLA - PROFIL U



a†	b	c			Cod.
72	4 Mts	26	Aluminio Aluminum Aluminium		400 A
72	4 Mts	26	Blanco White Blanc		400 B
72	4 Mts	26	Negro Black Noir		400 N
72	4 Mts	26	Oro Grata Grata Gold Or Grata		400 O

GOLA - PERFIL VERTICAL DOBLE

GOLA - PROFILE VERTICAL DOUBLE | GOLA - PROFIL VERTICAL DOUBLER

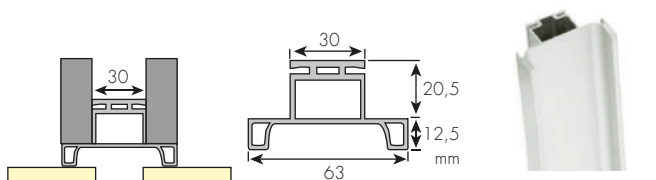

a†	b	c			Cod.
4,6 Mts	63	12,5	Aluminio Aluminum Aluminium		460 A
4,6 Mts	63	12,5	Blanco White Blanc		460 B
4,6 Mts	63	12,5	Negro Black Noir		460 N
4,6 Mts	63	12,5	Oro Grata Grata Gold Or Grata		460 O

GOLA - PERFIL VERTICAL SIMPLE

GOLA - PROFILE VERTICAL SIMPLE | GOLA - PROFIL VERTICAL SIMPLES

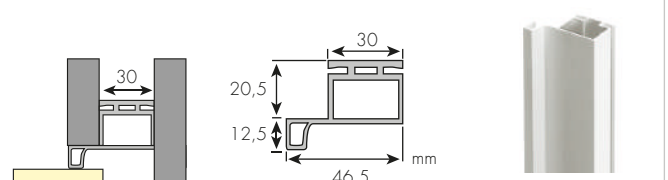

a†	b	c			Cod.
4,6 Mts	46,5	12,5	Aluminio Aluminum Aluminium		460 A
4,6 Mts	46,5	12,5	Blanco White Blanc		460 B
4,6 Mts	46,5	12,5	Negro Black Noir		460 N
4,6 Mts	46,5	12,5	Oro Grata Grata Gold Or Grata		460 O

GOLA - RINCON PERFIL J / ESQUINA PERFIL J

INSIDE / OUTSIDE CORNER | COIN EXTERNE / INTÉRIEUR

Rincón | Inside | Intérieur

a†	b			Cod.
57	29	Aluminio Aluminum Aluminium		803921 - A
57	29	Blanco White Blanc		803921 - B
57	29	Negro Black Noir		803921 - N
57	29	Oro Grata Grata Gold Or Grata		803921 - O

Esquina | Outside | Extérieur

a†	b			Cod.
57	27	Aluminio Aluminum Aluminium		803922 - A
57	27	Blanco White Blanc		803922 - B
57	27	Negro Black Noir		803922 - N
57	27	Oro Grata Grata Gold Or Grata		803922 - O

GOLA - JUEGO TAPA PERFIL J / U

GOLA - PROFILE J/U COVER SET | GOLA - JEU CAPS PROFIL J/U

a†	b	c			Cod.
57	26	1,5	Aluminio Aluminum Aluminium		803931 - A
57	26	1,5	Blanco White Blanc		803931 - B
57	26	1,5	Negro Black Noir		803931 - N
57	26	1,5	Oro Grata Grata Gold Or Grata		803931 - O



a†	b	c			Cod.
72	26	1,5	Aluminio Aluminum Aluminium		803932 - A
72	26	1,5	Blanco White Blanc		803932 - B
72	26	1,5	Negro Black Noir		803932 - N
72	26	1,5	Oro Grata Grata Gold Or Grata		803932 - O



GOLA - KIT FIJACIÓN

GOLA - FIXING KIT | GOLA - KIT DE FIXATION



Cod.
803911

SERIE GOLA PLANO

GOLA - PERFIL HORIZONTAL PLANO J

GOLA - PROFILE FLAT J | GOLA - PROFIL PLAT J

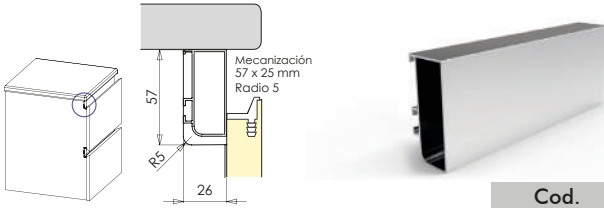

a†	b	C				Cod.
57	4 Mts	26	Aluminio Aluminum Aluminium		400	A
57	4 Mts	26	Blanco White Blanc		400	B
57	4 Mts	26	Negro Black Noir		400	N
57	4 Mts	26	Oro Grata Grata Gold Or Grata		400	O

GOLA - PERFIL HORIZONTAL PLANO U

GOLA - PROFILE FLAT U | GOLA - PROFIL PLAT U

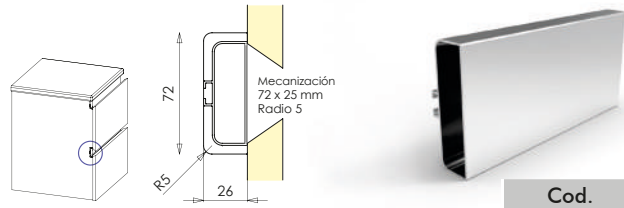

a†	b	C				Cod.
72	4 Mts	26	Aluminio Aluminum Aluminium		400	A
72	4 Mts	26	Blanco White Blanc		400	B
72	4 Mts	26	Negro Black Noir		400	N
72	4 Mts	26	Oro Grata Grata Gold Or Grata		400	O

GOLA - PERFIL VERTICAL PLANO DOBLE

GOLA - PROFILE VERTICAL FLAT DOUBLE | GOLA - PROFIL VERTICAL PLAT DOUBLER



a†	b	C				Cod.
4,7 Mts	63	12,5	Aluminio Aluminum Aluminium		460	A
4,7 Mts	63	12,5	Blanco White Blanc		460	B
4,7 Mts	63	12,5	Negro Black Noir		460	N
4,7 Mts	63	12,5	Oro Grata Grata Gold Or Grata		460	O

GOLA - PERFIL VERTICAL PLANO SIMPLE

GOLA - PROFILE VERTICAL FLAT SIMPLE | GOLA - PROFIL VERTICAL PLAT SIMPLES

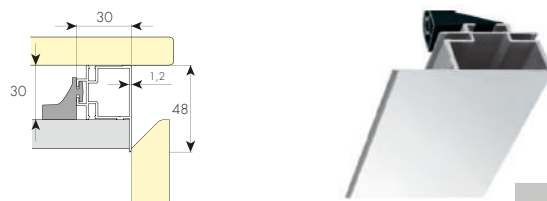

a†	b	C				Cod.
4,7 Mts	46,5	12,5	Aluminio Aluminum Aluminium		460	A
4,7 Mts	46,5	12,5	Blanco White Blanc		460	B
4,7 Mts	46,5	12,5	Negro Black Noir		460	N
4,7 Mts	46,5	12,5	Oro Grata Grata Gold Or Grata		460	O

GOLA PLANO - CROQUIS DE INSTALACIÓN VERTICAL

GOLA FLAT - SKETCH OF INSTALLATION VERTICAL
GOLA PLAT - CROQUIS DE L'INSTALLATION VERTICALE

GOLA - PERFIL PLANO SIMPLE

GOLA - PROFILE FLAT SIMPLE
GOLA - PROFIL PLAT SIMPLES

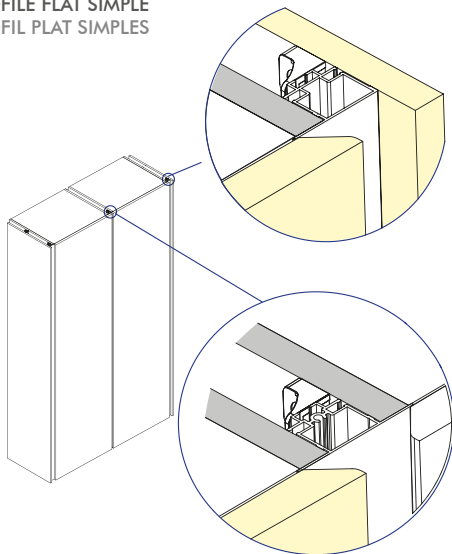

GOLA - PERFIL PLANO DOBLE

GOLA - PROFILE FLAT DOUBLE
GOLA - PROFIL PLAT DOUBLER

GOLA - KIT FIJACIÓN PERFIL SIMPLE

GOLA - FIXING KIT PROFILE SIMPLE | GOLA - KIT DE FIXATION PROFIL SIMPLES



Cod.
803912

NEW

GOLA - PERFIL ALTO

GOLA - PROFILE HIGH | GOLA - PROFIL ÉLEVÉ

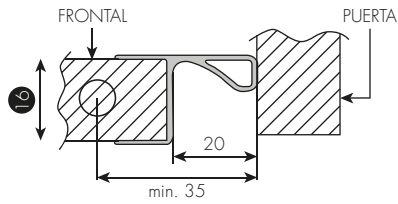
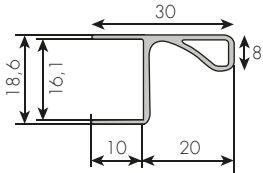
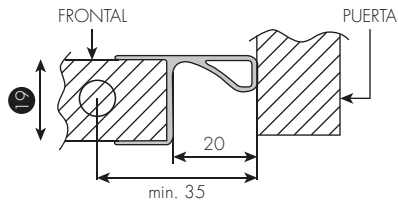
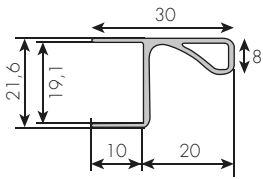

				Cod.	
a†	b	c/		803905	
16	4,1 Mts	22	Aluminio Aluminum Aluminium		300 A16
16	4,1 Mts	22	Blanco White Blanc		300 B16
19	4,1 Mts	22	Blanco White Blanc		300 B19
19	4,1 Mts	22	Antracita Anthracite Anthracite		300 AT19